



Outils De Service

Numéro de l'outil	Description	Numéro de l'outil	Description
18G.47	Presse manuelle	S.4221A	Presse manuelle
18G.47BD	Outil de dépose de roulement de porte-différentiel	S.4221A-5	Outil de dépose/repose de ressorts hélicoïdaux
18G.106	Presse de ressorts de soupapes	S.4221A-7B	Adaptateur de dépose/repose de roulement d'arbre de roue intérieur.
18G.131C	Extenseur de carter de différentiel	S.4221A-14	Adaptateur de dépose de roulement de moyeu arrière
18G.131E	Jeu d'adaptateurs d'extension de carter de différentiel	S.4221A-17	Outil de dépose/repose de roulements de pignon d'attaque
18G.134DH	Outil de repose de roulement de différentiel	S.4221A-19	Adaptateur de dépose/repose de chemin de roulement à billes d'arbre secondaire de boîte de vitesses
18G.191	Indicateur de hauteur de pignon	4235A	Marteau coulissant
18G.191M	Faux-pignon	S.4235A-2	Outil de dépose/adaptateur de pignon à prise constante
60A	Outil de dépose/repose de guides de soupapes	6118B	Outil de compression de ressort de soupape
S.60A-2A	Adaptateur de dépose/repose de guides de soupapes	S.6118B-1	Adaptateur de compresseur de ressorts de soupapes
S.101	Extenseur de carter de différentiel		
S.109C	Outil de dépose de moyeu		
S.144	Outil de dépose de circlips d'arbre secondaire		
S.145	Outil de repose de circlips d'arbre secondaire		
S.160	Outil de séparation de joint à rotule		
S.300A	Outil de dépose/repose de roulement à aiguille de moyeu arrière.		
S.304	Outil de repose de roulement à bille de moyeu		
S.306	Clé dynamométrique de réglage de frein		
S.314	Outil de repose de roulement à billes d'arbre secondaire		
335	Gabarit d'équerrage de bielle		
S.336-4	Adaptateur de mandrin pour bielle		
S.337	Outil de retenue de flasque		
S.341	Outil de compression de montage de crémaillère		
S.353	Outil de réglage de carburateur		
RG.421	Clé de retenue de flasque réglable		
550	Poignée d'entraînement		
3072A	Marteau coulissant		

OUTILS POUR OVERDRIVE

L.178	Bague d'ensemble de roue libre
L.183A	Outil de dépose de cylindre de pompe
L.183A-2A	Adaptateur
L.188	Équipement d'essai hydraulique
L.201	Faux-arbre de transmission
L.202A	Outil de dépose de roulement à billes d'arbre de sortie
L.206A	Outil de repose du corps de pompe à huile
L.213	Clé de corps de pompe à huile

Pour se procurer tous les outils mentionnés dans ce manuel, on est prié de s'adresser au fabricant:

Messrs. V. L. Churchill & Co. Ltd.,
P.O. Box No. 3
London Road,
Daventry, Northants.,
ANGLETERRE.



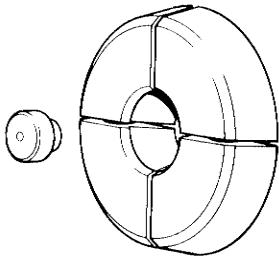

18G.47BD

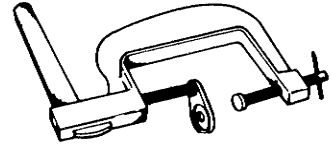

18G.106

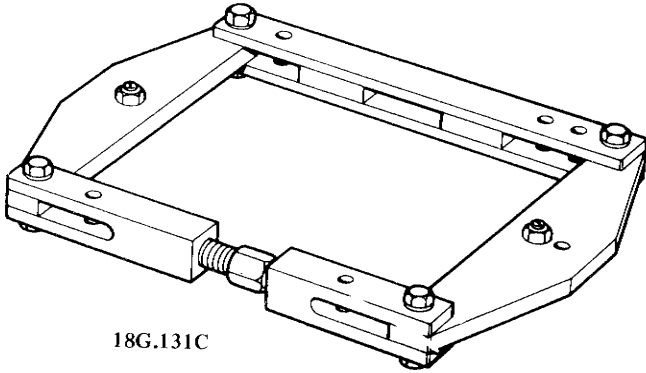

18G.131C

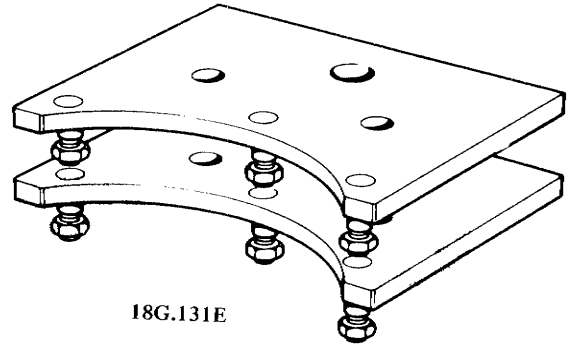

18G.131E

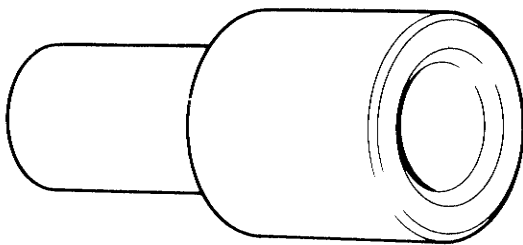

18G.134DH

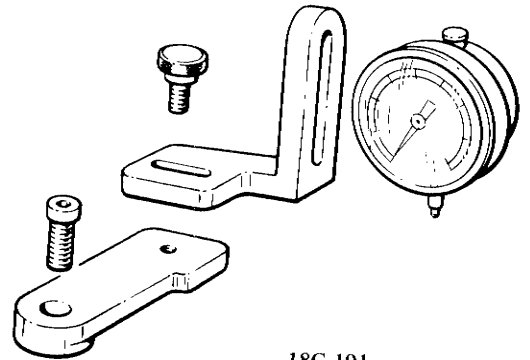

18G.191

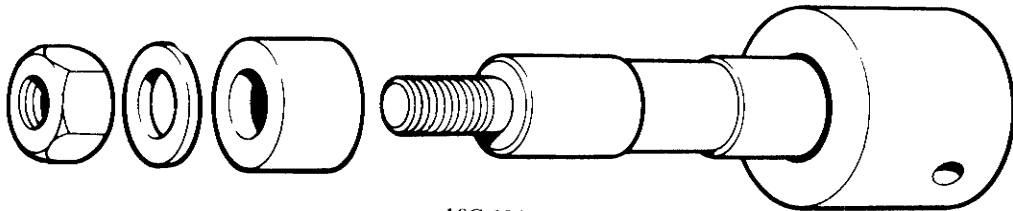

18G.191M

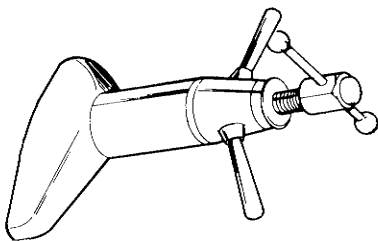

60A

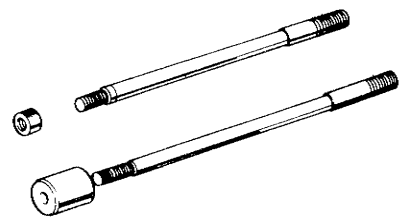

S60A-2



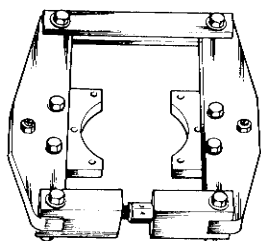

S.101

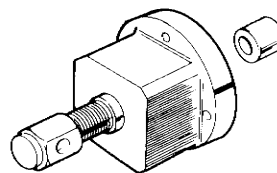

S.109C

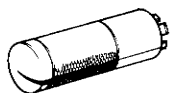

S.144

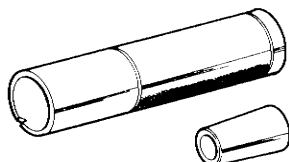

S.145

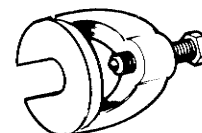

S.160

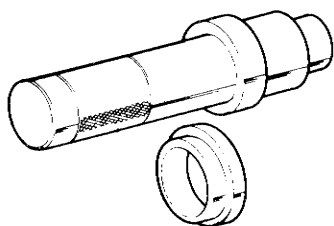

S.300A

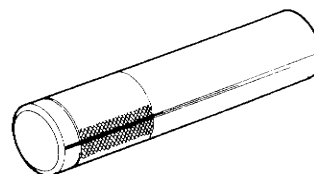

S.304

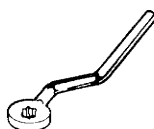

S.306

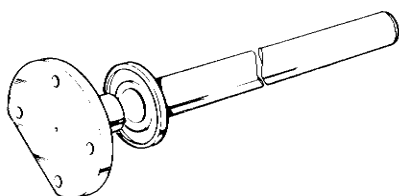

S.314

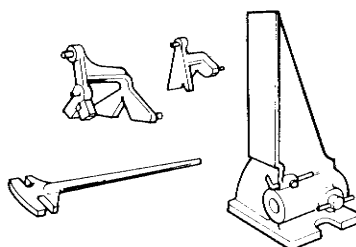

335

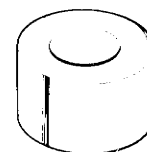

S.336-4



S.337

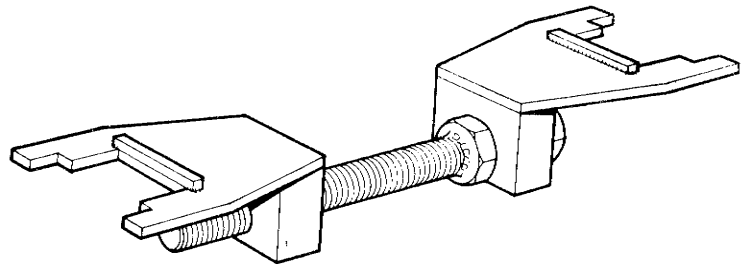

S.341

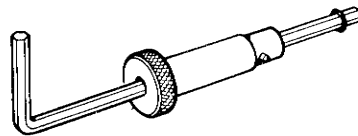

S.353



550

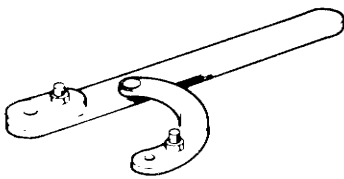

RG.421

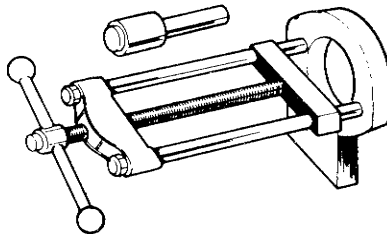

S.4221A

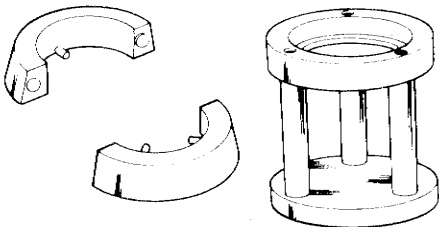

S.4221A-5

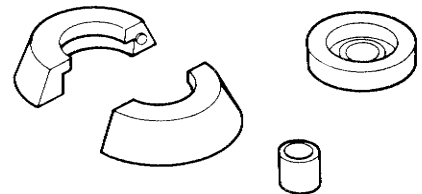

S.4221A-7B

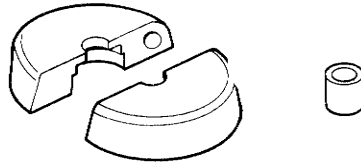

S.4221A-14

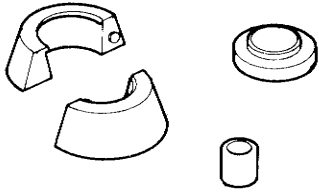

S.4221A-17

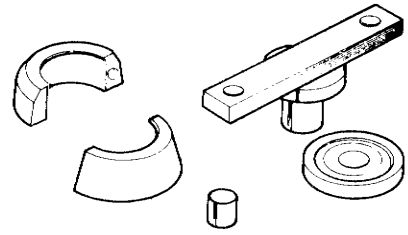

S.4221A-19

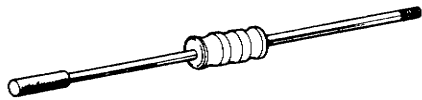

4235A

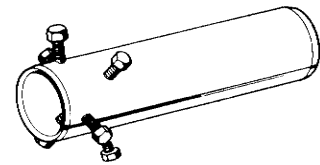

S.4235A-2

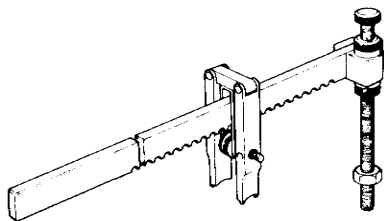

6118B

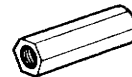

S.6118-1

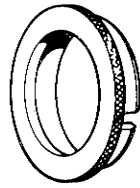

L.178

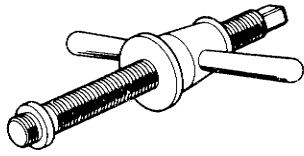

L.183A

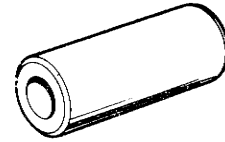

L.183A-2A



L.188

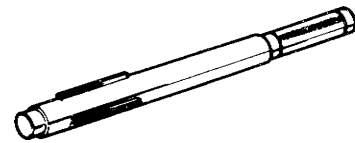

L.201

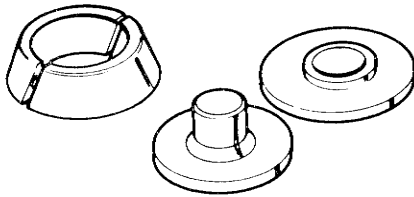

L.202A

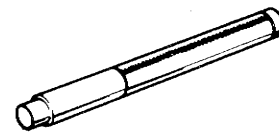

L.206A

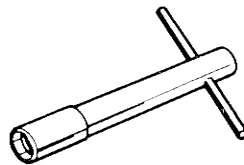

L.213

